

### QP UPS

L1	ALIMENT. DO QUADRO	VV 306	
L1	UPS - MONOF. MONOF. QUIT		
L1	UPS - MONOF. MONOF. QUIT		
L1	Circ.Tom. 1 - UPS	VV 302.5	PEAD40
L1	Circ.Tom. 2 - UPS	VV 302.5	PEAD40
L1	Circ.Tom. 3 - UPS	VV 302.5	PEAD40
L1	Circ.Tom. 4 - UPS	VV 302.5	CT 190/54
L1	BOITONEIRA CORTE UPS B03-0E	VV 2X1.5	VM 25
L1	BOITONEIRA CORTE UPS B03-0E	VV 2X1.5	VM 25
L1	Bobine de minima tensao		

### QP Parque

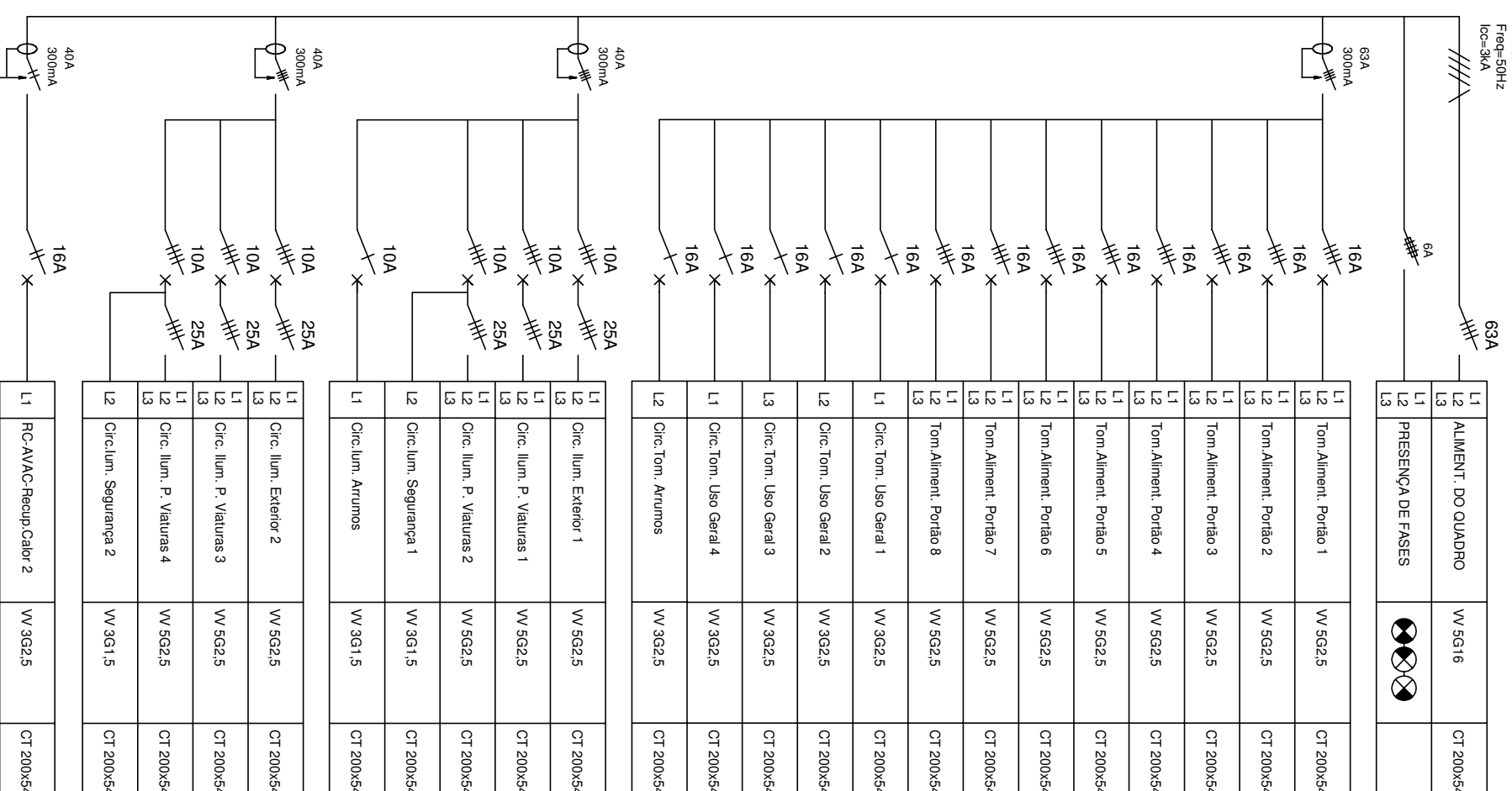

### QP Oficina

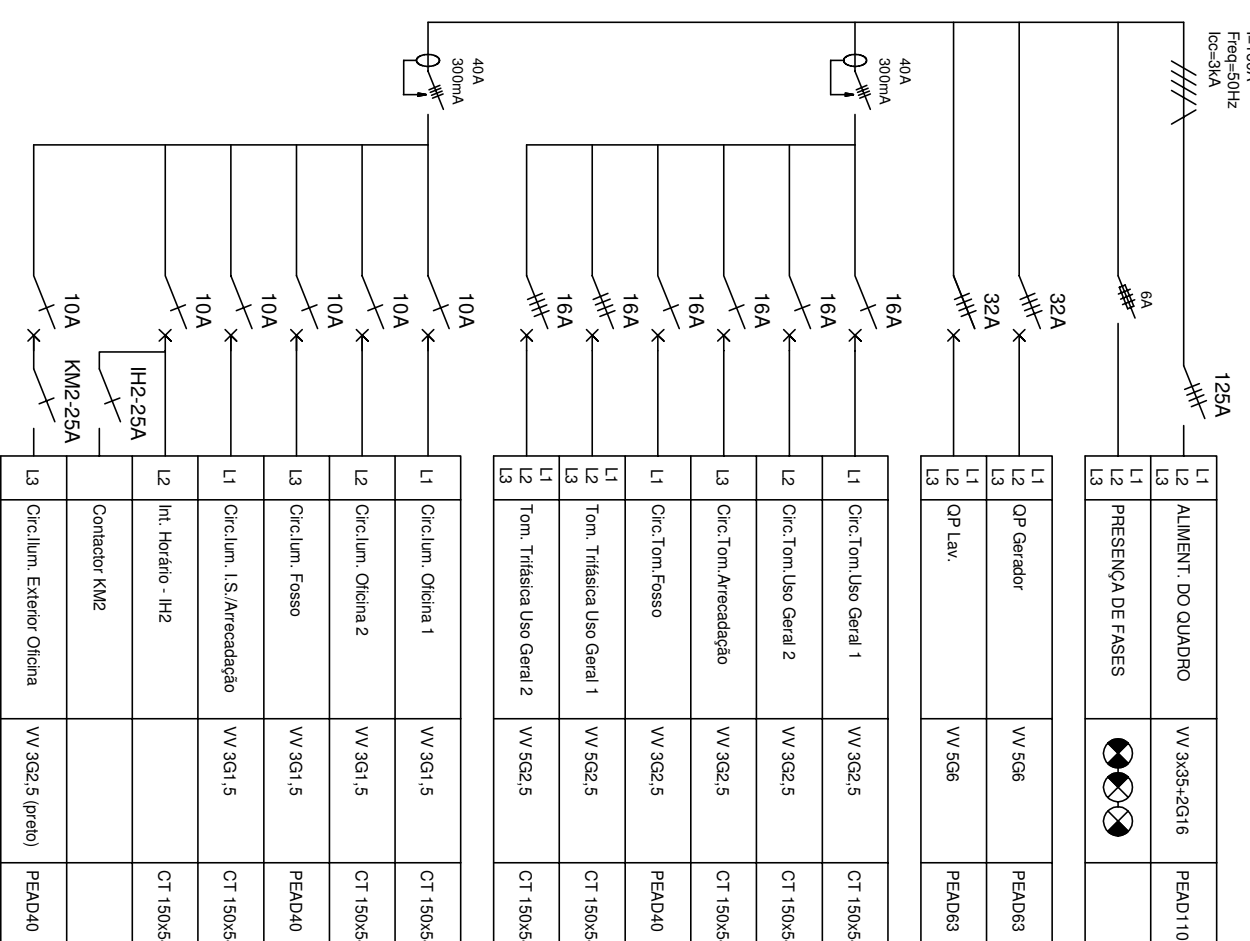

L1	ALIMENT. DO QUADRO	VV 305+3016	PEAD110
L1	PRESENCIA DE FASES		
L1	OP Gerador	VV 506	PEAD63
L1	OP Lav.	VV 506	PEAD63
L1	Circ.Tom. Uso Geral 1	VV 302.5	CT 150/54
L2	Circ.Tom. Uso Geral 2	VV 302.5	CT 150/54
L3	Circ.Tom. Arredondado	VV 302.5	CT 150/54
L1	Circ.Tom. Fisso	VV 302.5	PEAD40
L1	Tom. Trifasica Uso Geral 1	VV 502.5	CT 150/54
L1	Tom. Trifasica Uso Geral 2	VV 502.5	CT 150/54

### QP 1

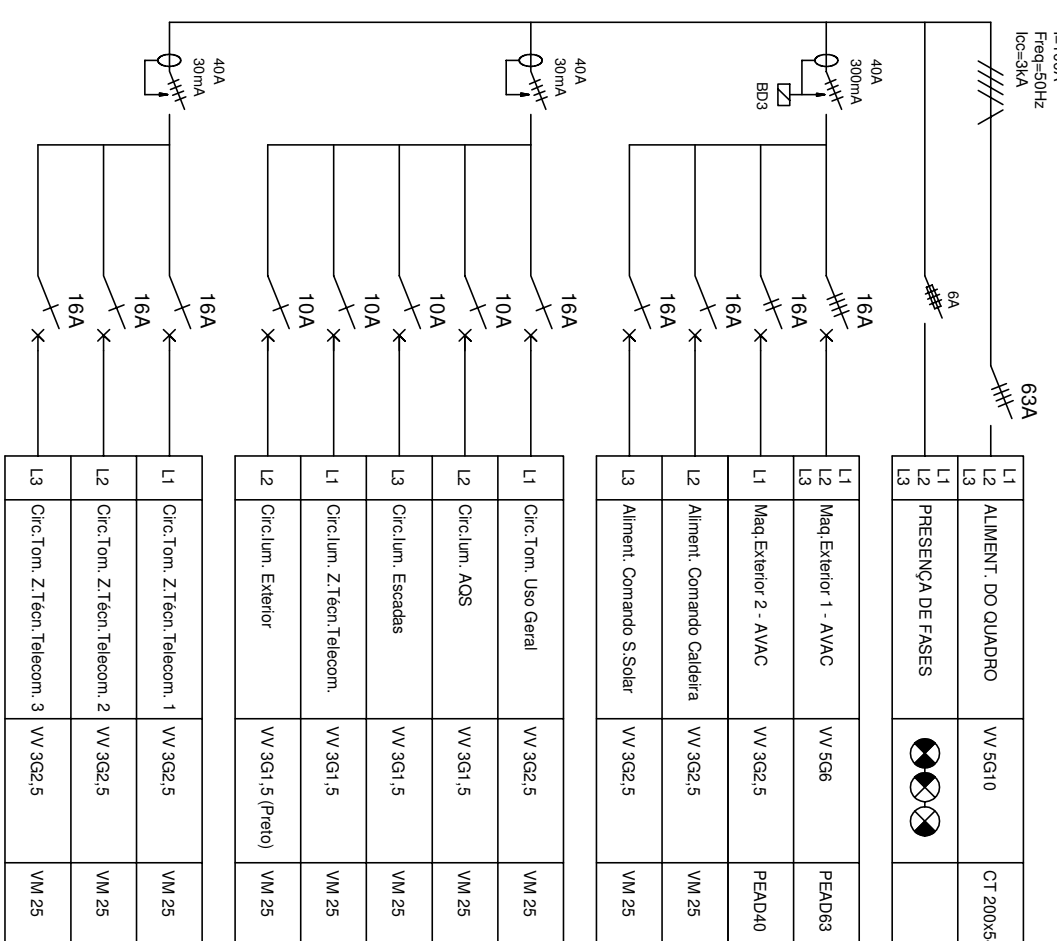

L1	ALIMENT. DO QUADRO	VV 5010	CT 200/54
L1	PRESENCIA DE FASES		
L1	Mat. Exterior 1 - AVAC	VV 506	PEAD63
L1	Mat. Exterior 2 - AVAC	VV 302.5	PEAD40
L2	Aliment. Comando Chiller	VV 302.5	VM 25
L3	Aliment. Comando S. Sber	VV 302.5	VM 25
L1	Circ.Tom. Uso Geral	VV 302.5	VM 25
L2	Circ.Tom. ACS	VV 301.5	VM 25
L3	Circ.Tom. Escadas	VV 301.5	VM 25
L1	Circ.Tom. Z.Tecm. Telecom.	VV 301.5	VM 25
L2	Circ.Tom. Z.Tecm. Telecom.	VV 302.5	VM 25

### QP Alarme

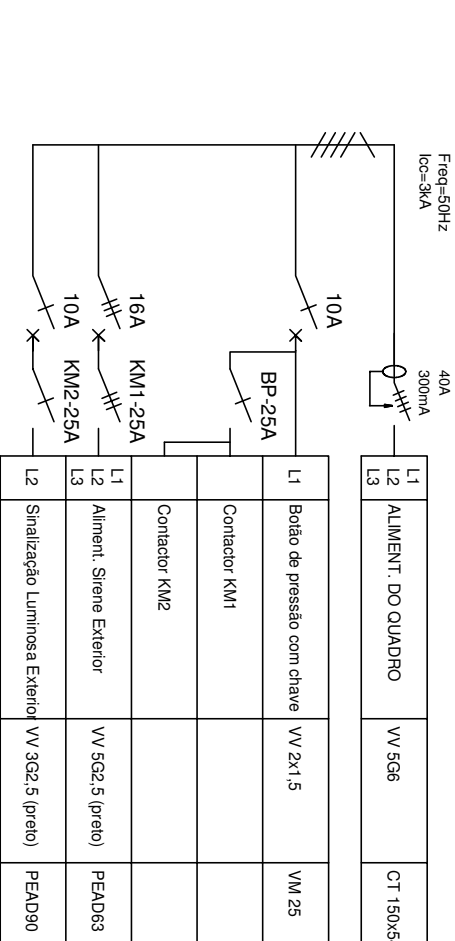

L1	ALIMENT. DO QUADRO	VV 506	CT 150/54
L1	Bobine de pressao com chave	VV 2X1.5	VM 25
L1	Contator KMI		
L1	Contator KMI		
L1	Aliment. Sirene Exterior	VV 502.5 (preto)	PEAD63
L2	Sinalizagao Luminosa Exterior	VV 302.5 (preto)	PEAD90

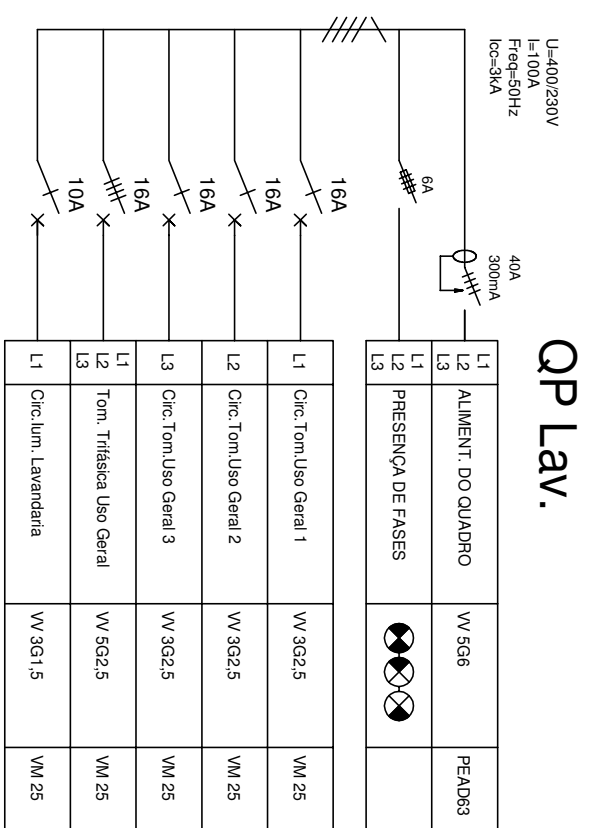

### QP Lav.

L1	ALIMENT. DO QUADRO	VV 506	PEAD63
L1	PRESENCIA DE FASES		
L1	Circ.Tom. Uso Geral 1	VV 302.5	VM 25
L2	Circ.Tom. Uso Geral 2	VV 302.5	VM 25
L3	Circ.Tom. Uso Geral 3	VV 302.5	VM 25
L1	Tom. Trifasica Uso Geral	VV 502.5	VM 25
L1	Circ. lum. Lavandaria	VV 301.5	VM 25

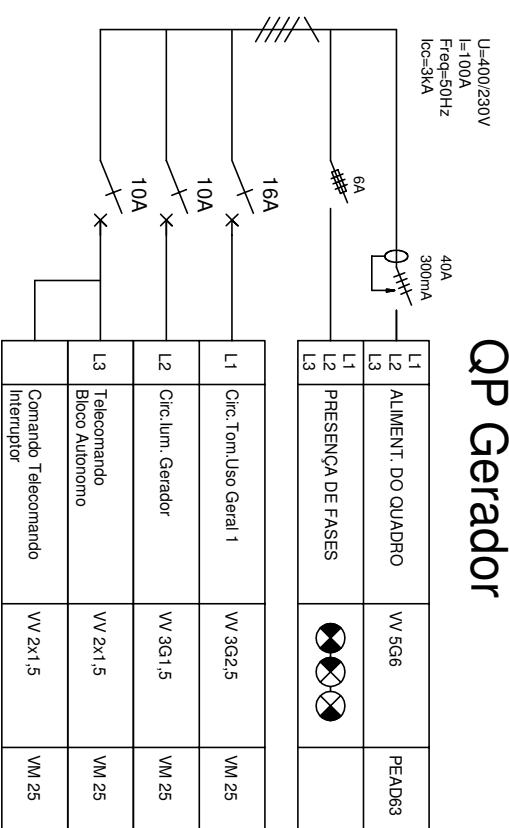

### QP Gerador

L1	ALIMENT. DO QUADRO	VV 506	PEAD63
L1	PRESENCIA DE FASES		
L1	Circ.Tom. Uso Geral 1	VV 302.5	VM 25
L2	Circ. lum. Gerador	VV 301.5	VM 25
L3	Recomando Bico Alimentar	VV 2X1.5	VM 25
L3	Comando Telecomando Intermitor	VV 2X1.5	VM 25

### Gerador

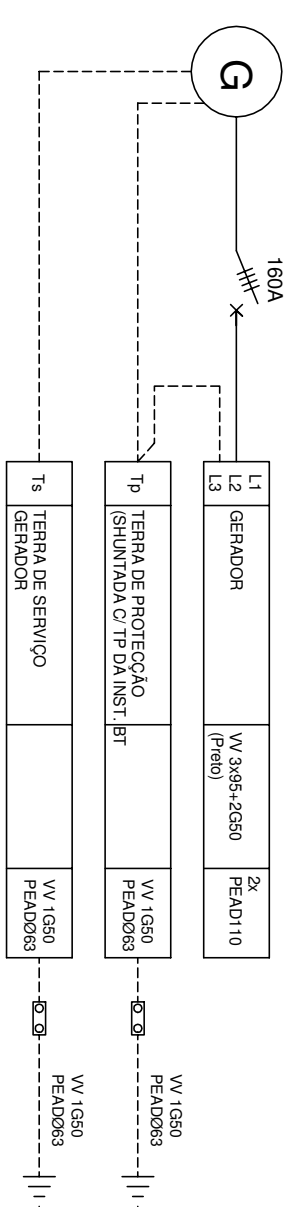

## Diagrama de Quadros

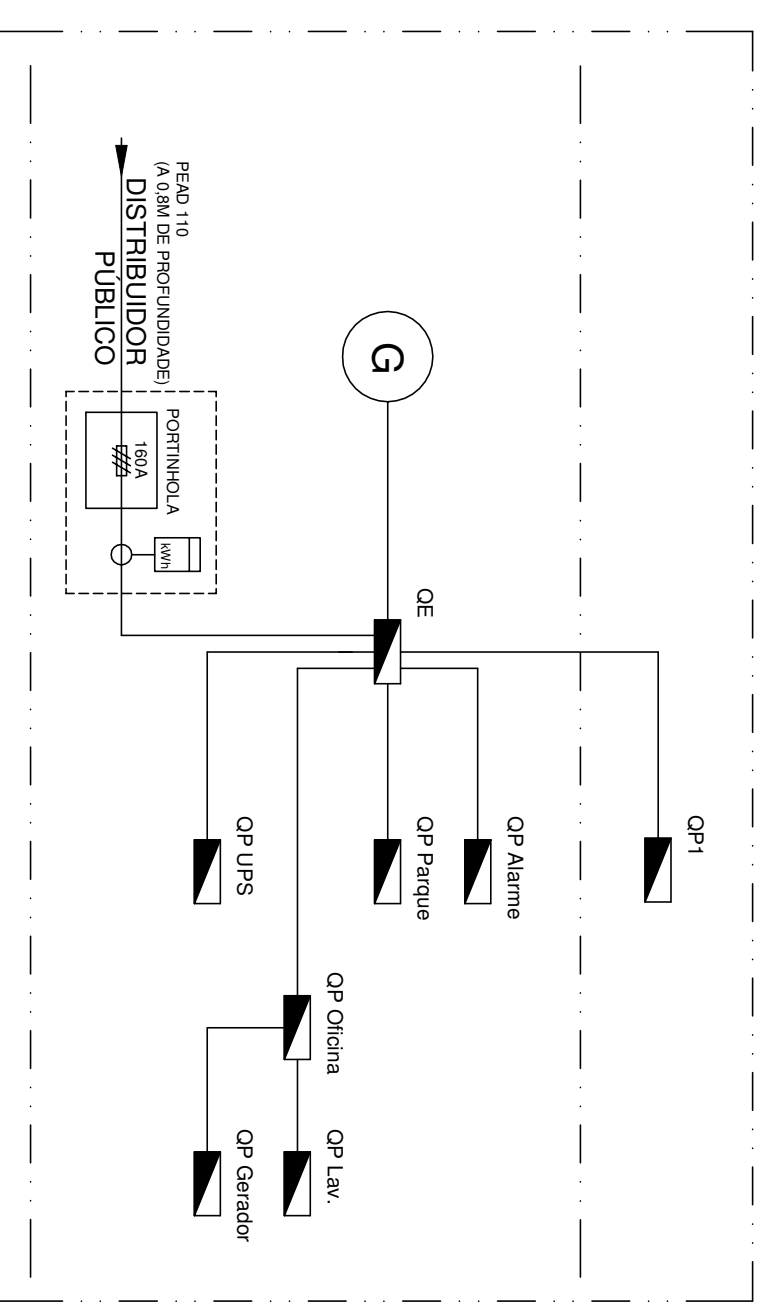

Desenho Assinado, Por: Computador, Processado em: Allocated 2004 LTT, Licença n.º 341.636750164

Projeto : Elétrico  
 Requerente : Associação Humanitária dos Bombeiros Voluntários de Bombarrel  
 Local : Praca da Republica  
 Obra : Bombarrel  
 Título : Esquema dos quadros electricos - QP UPS, QP Parque, QP Oficina, QP 1, OP Lav, OP Gerador e Diagrama de quadros  
 Técnico Responsável :  
 Data : 24/10/2008  
 Escala :  
 Desenho n.º : 8